

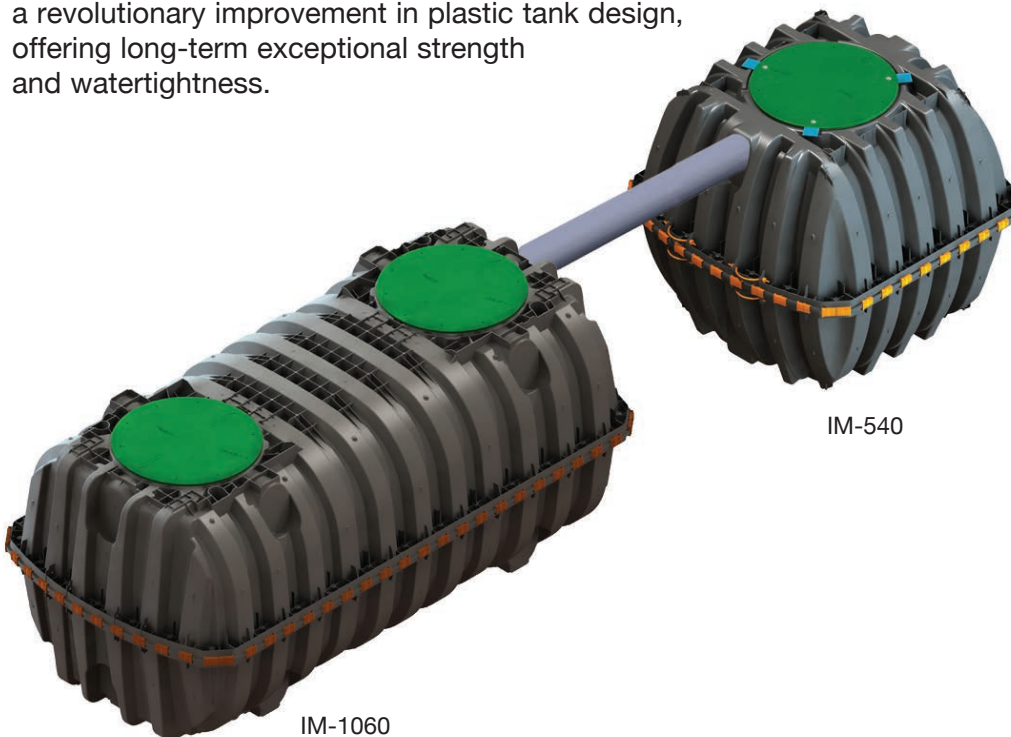

Reinforced watertight mid-seam gasketed connection

■ **Lightweight strong and durable septic/pump tank, making it optimal for use in-series with other tanks**

This watertight tank design is offered with Infiltrator's line of custom-fit risers and heavy-duty lids. Infiltrator injection molded tanks provide a revolutionary improvement in plastic tank design, offering long-term exceptional strength and watertightness.



IM-1060

IM-540

### Applications

**Retrofit:** The IM-540 can increase the volume of an existing septic tank.

**New:** Use the IM-540 in new in-series installations with another tank.

**Trash/Pump-Tank:** Ideally-sized for use as a trash-tank or pump tank.

### Features & Benefits

- Strong injection molded polypropylene construction
- Lightweight plastic construction and inboard lifting lugs allow for easy delivery and handling
- Integral heavy-duty green lids that interconnect with TW™ risers and pipe riser solutions
- Structurally reinforced access ports eliminate distortion during installation and pump-outs
- Reinforced structural ribbing offers additional strength
- Can be installed with 6" to 48" of cover
- Can be pumped dry during pump-outs
- No special installation, backfill or water filling procedures are required

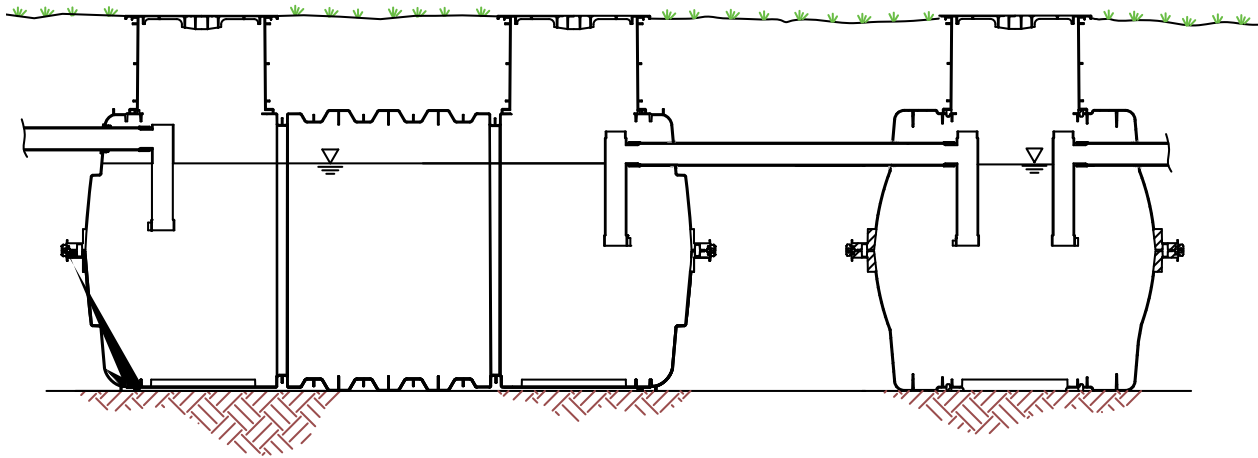

The IM-540 is an injection molded two piece mid-seam plastic tank. The injection molded plastic design allows for a mid-seam joint that has precise dimensions for accepting an engineered EPDM gasket. Infiltrator's gasket design utilizes technology from the water industry to deliver proven means of maintaining a watertight seal. The two-piece design is permanently fastened using a series of non-corrosive plastic alignment dowels and locking seam clips. The IM-540 is assembled and sold through a network of certified Infiltrator distributors.

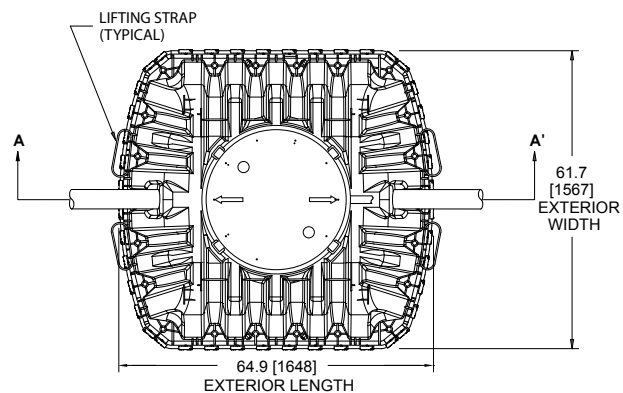

TOP VIEW

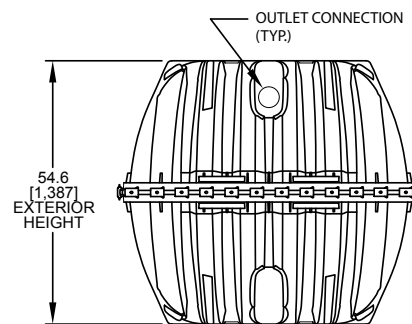

END VIEW

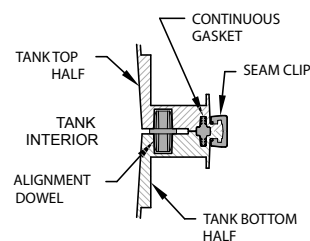

MID-HEIGHT SEAM SECTION DETAIL

**IM-540**

Working Capacity	475 gal (1799 L)
Total Capacity	552 gal (2090 L)
Airspace	16.2%
Length	64.9" (1648 mm)
Width	61.7" (1567 mm)
Height	54.6" (1387 mm)
Liquid Level	44" (1118 mm)
Compartments	1
Maximum Burial Depth	48" (1219 mm)
Minimum Burial Depth	6" (152 mm)
Maximum Pipe Diameter	4" (100 mm)
Weight	169 lbs (77 kg)



4 Business Park Road  
P.O. Box 768  
Old Saybrook, CT 06475  
860-577-7000 • Fax 860-577-7001  
**1-800-221-4436**  
[www.infiltratorsystems.com](http://www.infiltratorsystems.com)

U.S. Patents: 4,759,661; 5,017,041; 5,156,488; 5,336,017; 5,401,116; 5,401,459; 5,511,903; 5,716,163; 5,588,778; 5,839,844 Canadian Patents: 1,329,959; 2,004,564 Other patents pending. Infiltrator, Equalizer, Quick4, and SideWinder are registered trademarks of Infiltrator Systems Inc. Infiltrator is a registered trademark in France. Infiltrator Systems Inc. is a registered trademark in Mexico. Contour, MicroLeaching, PolyTuff, ChamberSpacer, MultiPort, PosiLock, QuickCut, QuickPlay, SnapLock and StraightLock are trademarks of Infiltrator Systems Inc. PolyLok is a trademark of PolyLok, Inc. TUF-TITE is a registered trademark of TUF-TITE, INC. Ultra-Rib is a trademark of IPEX Inc.

© 2013 Infiltrator Systems Inc. All rights reserved. Printed in U.S.A.

IM19 0813

**Contact Infiltrator Systems' Technical Services Department for assistance at 1-800-221-4436**